

Custom Load Pin Design Options

Custom Load Pin design options

1. Dual shear plane type

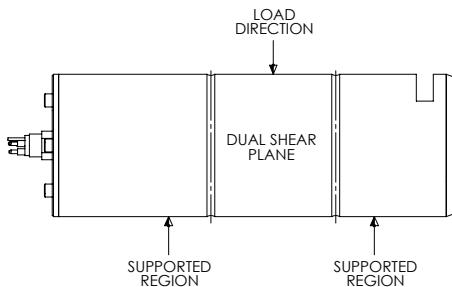

2. Single shear plane cantilever pin

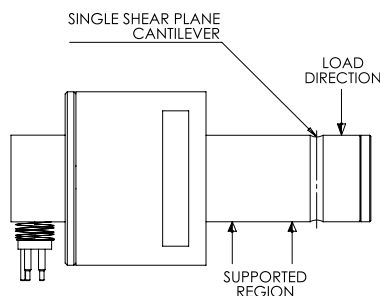

Locking options

1. Lock plate (1 to 4 locking slots)

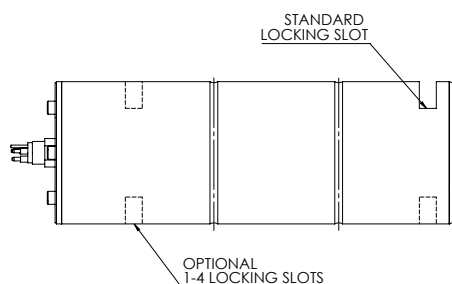

2. Anti-Rotation – thread and nut split pin

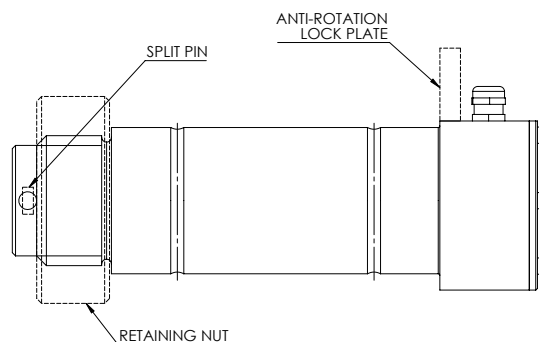

Cable entry options

1. Radial – connector or cable gland

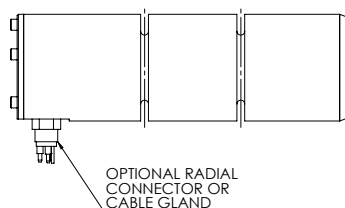

2. Axial – connector or cable gland

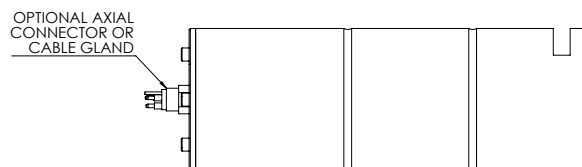

Dimensional Data

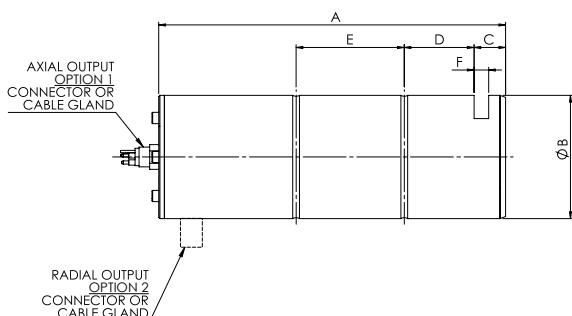

Features:

- Stainless steel construction
- FEA verified designs
- Down hole gauged for high protection
- IP67/IP68 ratings and robust construction
- Removable end caps for easy serviceability and excellent sealing